

18.0-50.0 GHz GaAs MMIC Distributed Amplifier

January 2010 - Rev 11-Jan-10

Features

- ✕ Ultra Wide Band Driver Amplifier
- ✕ Fiber Optic Modulator Driver
- ✕ 17.0 dB Small Signal Gain
- ✕ 5.0 dB Noise Figure
- ✕ 30 dB Gain Control
- ✕ +15.0 dBm P1dB Compression Point
- ✕ 100% On-Wafer RF, DC and Output Power Testing
- ✕ 100% Visual Inspection to MIL-STD-883 Method 2010

General Description

Mimix Broadband's 18.0-50.0 GHz GaAs MMIC distributed amplifier has a small signal gain of 17.0 dB with a noise figure of 5.0 dB across the band. The device also includes 30.0 dB gain control and a +15 dBm P1dB compression point. This MMIC uses Mimix Broadband's GaAs PHEMT device model technology, and is based upon electron beam lithography to ensure high repeatability and uniformity. The chip has surface passivation to protect and provide a rugged part with backside via holes and gold metallization to allow either a conductive epoxy or eutectic solder die attach process. This device is well suited for microwave, millimeter-wave and wideband military applications.

Chip Device Layout



Absolute Maximum Ratings

Supply Voltage (Vd)	+6.0 VDC
Supply Current (Id)	220 mA
Gate Bias Voltage (Vg)	+0.3 VDC
Input Power (Pin)	+15 dBm
Storage Temperature (Tstg)	-65 to +165 °C
Operating Temperature (Ta)	-55 to +85 °C
Channel Temperature (Tch) ¹	+175 °C

(1) Channel temperature affects a device's MTTF. It is recommended to keep channel temperature as low as possible for maximum life.

Electrical Characteristics (Ambient Temperature T = 25 °C)

Parameter	Units	Min.	Typ.	Max.
Frequency Range (f)	GHz	18.0	-	50.0
Input Return Loss (S11) ²	dB	5.0	10.0	-
Output Return Loss (S22) ²	dB	6.0	11.0	-
Small Signal Gain (S21) ²	dB	13.0	17.0	-
Gain Flatness ($\Delta S21$)	dB	-	+/-1.0	-
Gain Control	dB	-	30.0	-
Reverse Isolation (S12) ²	dB	30.0	40.0	-
Noise Figure (NF)	dB	-	5.0	-
Output Power for 1 dB Compression (P1dB) ¹	dBm	-	+15.0	-
Output Third Order Intercept Point (OIP3) ¹	dBm	-	+24.0	-
Drain Bias Voltage (Vd)	VDC	-	+5.0	+5.5
Gain Control Bias (Vg)	VDC	-2.0	0.0	+0.1
Supply Current (Id) (Vd=5.0V, Vg=0.0 Typical)	mA	-	160	190

(1) Measured using constant current.

(2) Unless otherwise indicated Min/Max over 18.0-50.0 GHz and biased at Vd=5V, Id=160 mA

18.0-50.0 GHz GaAs MMIC Distributed Amplifier

January 2010 - Rev 11-Jan-10

Distributed Amplifier Measurements (On-Wafer¹)

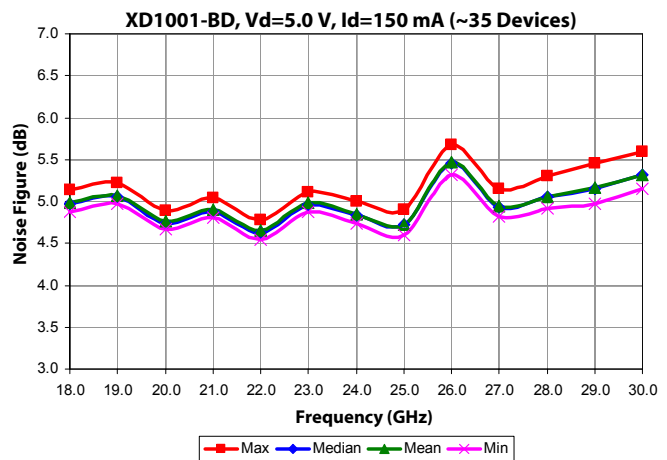
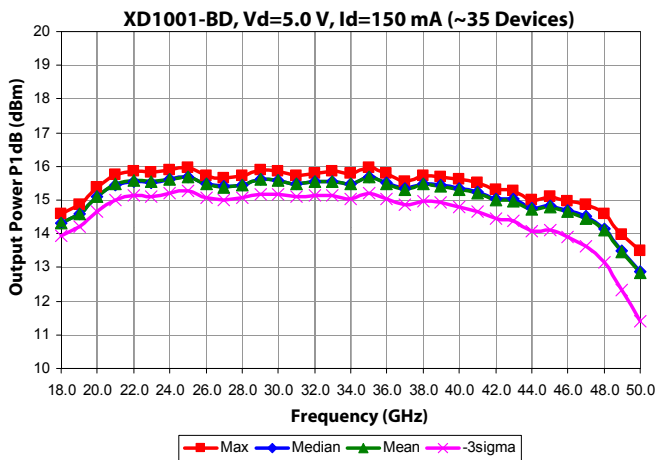
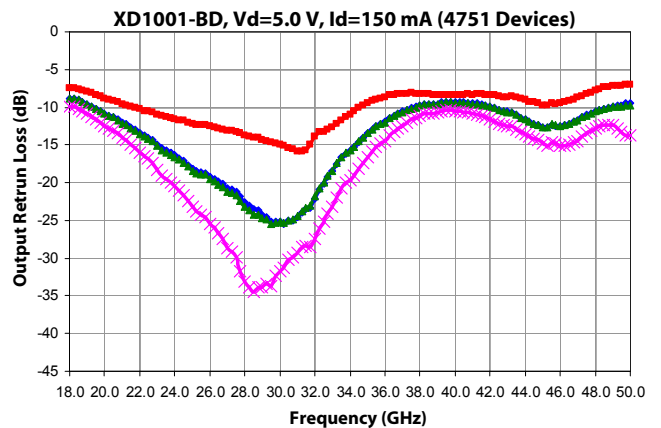
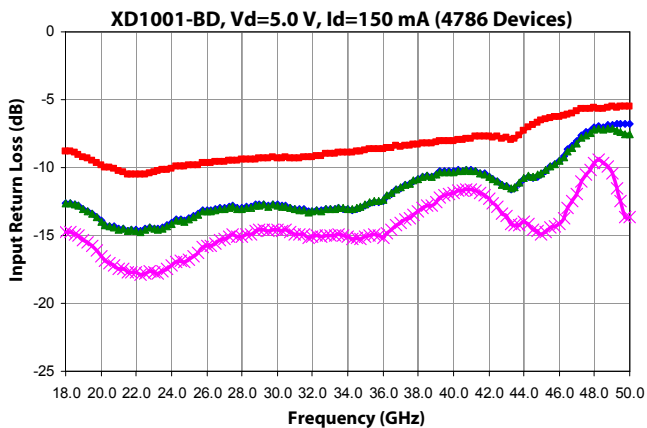
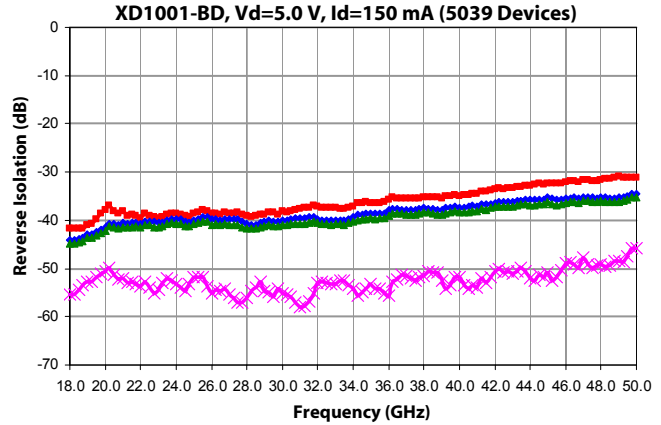
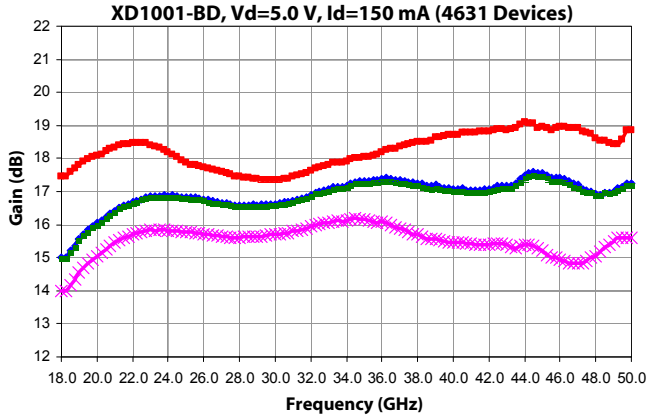

Note [1] Measurements – On-Wafer data has been taken using bias conditions as shown. Measurements are referenced 150 um in from RF In/Out pad edge. For optimum performance Mimix T-pad transition is recommended. For additional information see the Mimix “T-Pad Transition” application note.

18.0-50.0 GHz GaAs MMIC Distributed Amplifier

January 2010 - Rev 11-Jan-10

Distributed Amplifier Measurements (On-Wafer¹) (cont.)

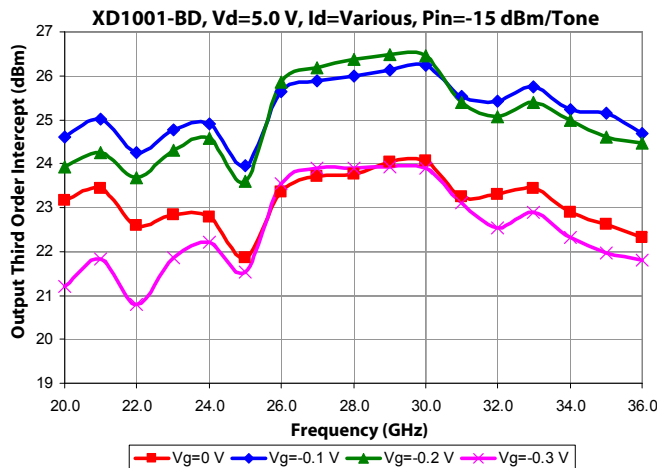
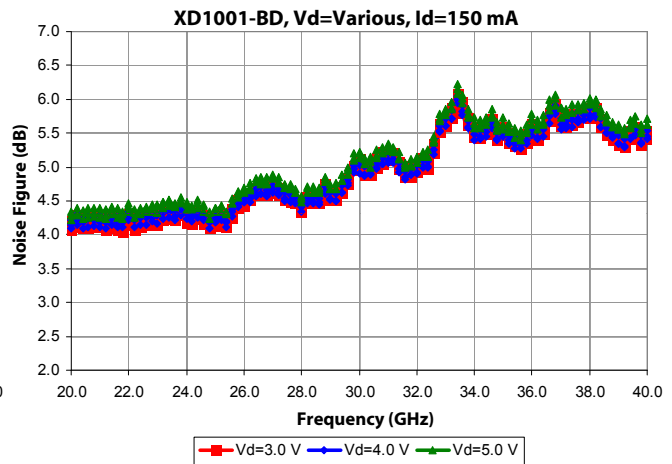
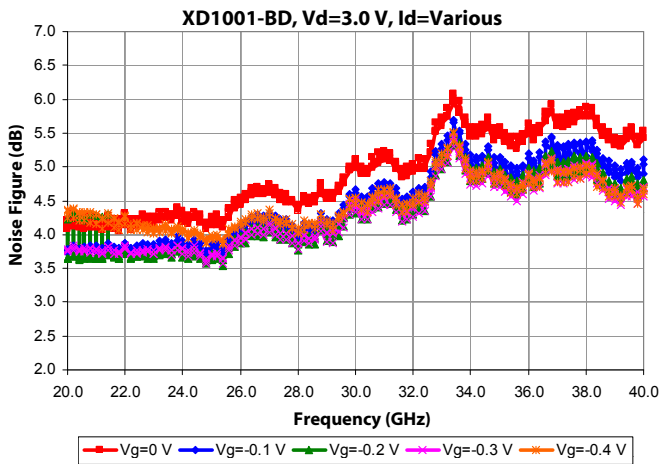
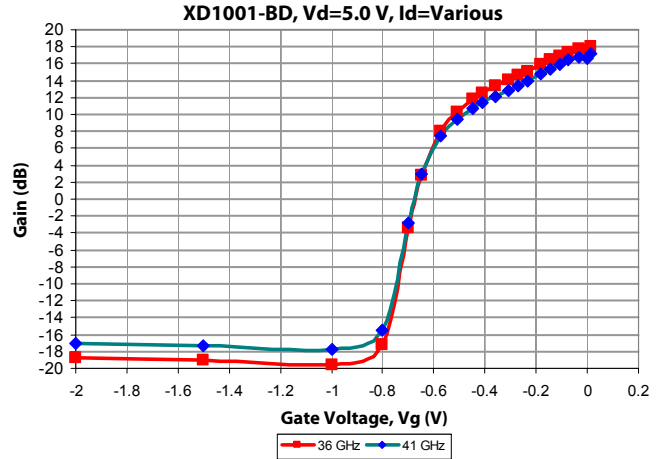
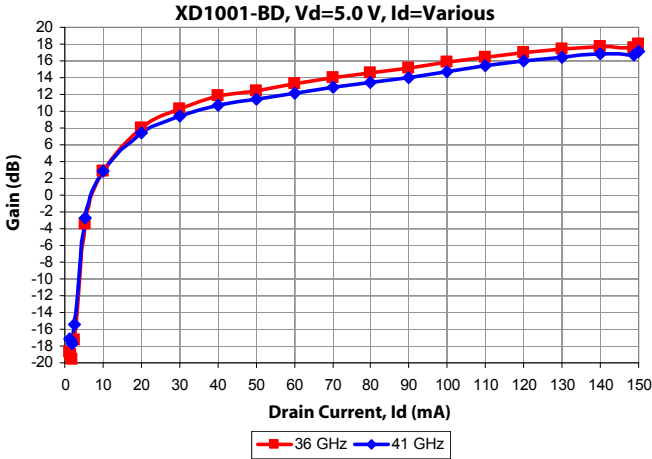

Note [1] Measurements – On-Wafer data has been taken using bias conditions as shown. Measurements are referenced 150 μ m in from RF In/Out pad edge. For optimum performance Mimix T-pad transition is recommended. For additional information see the Mimix "T-Pad Transition" application note.

18.0-50.0 GHz GaAs MMIC Distributed Amplifier

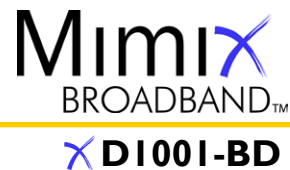

January 2010 - Rev 11-Jan-10

S-Parameters (On-Wafer¹)

Typical S-Parameter Data for XD1001-BD
Vd=5.0 V, Id=149 mA

Frequency (GHz)	S11 (Mag)	S11 (Ang)	S21 (Mag)	S21 (Ang)	S12 (Mag)	S12 (Ang)	S22 (Mag)	S22 (Ang)
14.0	0.339	-105.95	4.484	-64.44	0.0024	151.71	0.566	42.43
15.0	0.318	-109.42	4.959	-81.25	0.0029	146.08	0.536	29.71
16.0	0.296	-113.59	5.454	-98.28	0.0036	142.13	0.504	16.92
17.0	0.277	-118.09	5.957	-115.37	0.0043	129.03	0.469	3.70
18.0	0.263	-122.98	6.452	-132.70	0.0050	119.05	0.427	-9.98
19.0	0.248	-128.13	6.886	-150.61	0.0056	106.79	0.379	-24.20
20.0	0.227	-130.91	7.221	-168.63	0.0065	94.16	0.325	-38.39
21.0	0.219	-133.08	7.502	-173.62	0.0068	78.94	0.271	-53.12
22.0	0.218	-136.80	7.627	-155.96	0.0073	65.41	0.218	-66.82
23.0	0.222	-139.91	7.672	-138.78	0.0077	50.14	0.170	-79.26
24.0	0.225	-143.34	7.656	-122.19	0.0075	37.52	0.129	-89.38
25.0	0.233	-150.18	7.596	-106.11	0.0079	18.78	0.096	-98.45
26.0	0.242	-157.65	7.519	-90.71	0.0074	5.49	0.070	-103.92
27.0	0.250	-164.41	7.465	-75.62	0.0078	-6.83	0.059	-103.19
28.0	0.249	-172.29	7.404	-60.84	0.0078	-24.58	0.055	-99.36
29.0	0.248	-178.25	7.394	-46.58	0.0077	-41.51	0.060	-99.54
30.0	0.249	177.08	7.445	-32.02	0.0071	-55.57	0.083	-106.68
31.0	0.252	171.40	7.507	-17.23	0.0073	-69.66	0.108	-120.07
32.0	0.252	168.86	7.606	-2.06	0.0075	-85.07	0.141	-130.95
33.0	0.251	169.12	7.695	-13.87	0.0079	-104.67	0.178	-143.90
34.0	0.268	165.08	7.704	-29.86	0.0075	-121.74	0.211	-159.27
35.0	0.291	161.35	7.655	-45.93	0.0079	-135.09	0.243	-172.40
36.0	0.307	159.48	7.542	-62.26	0.0079	-152.32	0.275	-174.70
37.0	0.331	156.28	7.423	-78.77	0.0088	-165.75	0.305	-163.36
38.0	0.370	150.02	7.168	-94.50	0.0083	172.51	0.334	-151.74
39.0	0.384	144.92	6.983	-109.65	0.0090	160.60	0.351	-139.42
40.0	0.380	139.70	6.920	-125.06	0.0080	145.41	0.352	-129.53
41.0	0.390	136.35	6.827	-140.84	0.0087	134.33	0.352	-121.51
42.0	0.399	132.68	6.827	-156.36	0.0090	119.70	0.345	-112.70
43.0	0.407	128.89	6.929	-172.64	0.0091	106.25	0.331	-106.19
44.0	0.417	126.10	7.019	-169.64	0.0093	91.50	0.325	-100.85
45.0	0.407	124.13	6.992	-150.34	0.0094	78.26	0.313	-94.96
46.0	0.402	124.74	6.884	-131.08	0.0097	58.70	0.302	-93.66
47.0	0.436	122.89	6.794	-112.53	0.0099	33.85	0.306	-88.79
48.0	0.438	121.54	6.696	-92.46	0.0095	21.18	0.285	-82.69
49.0	0.426	118.51	6.662	-70.96	0.0098	-2.17	0.278	-78.04
50.0	0.412	114.78	7.002	-45.72	0.0101	-25.75	0.258	-68.40

Note [1] S-Parameters – On-Wafer S-Parameters have been taken using bias conditions as shown. Measurements are referenced 150 um in from RF In/Out pad edge.

18.0-50.0 GHz GaAs MMIC Distributed Amplifier

January 2010 - Rev 11-Jan-10

Mechanical Drawing

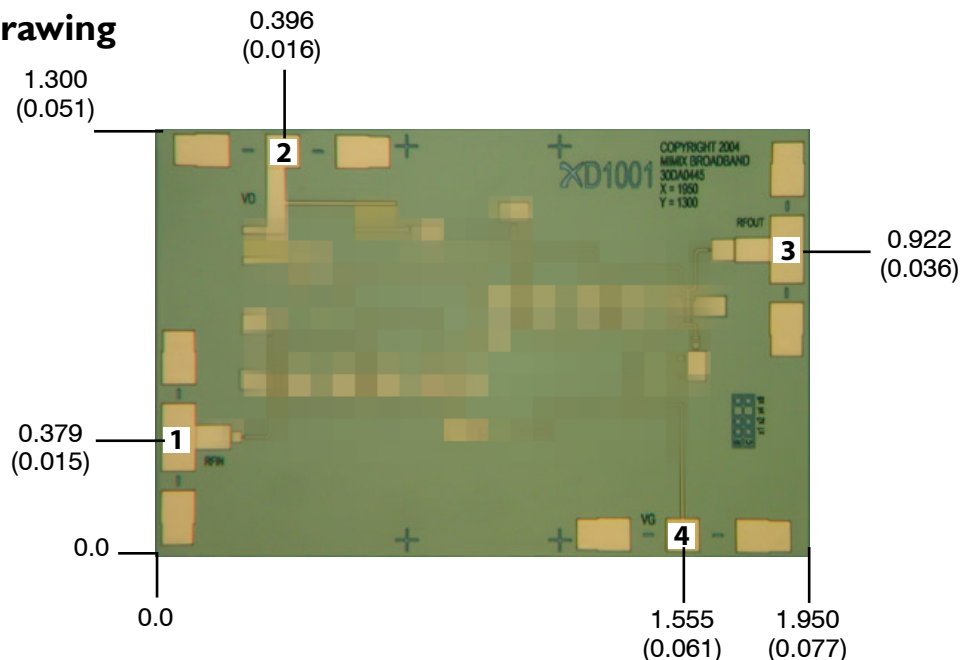

(Note: Engineering designator is 30DA0445)

Units: millimeters (inches) Bond pad dimensions are shown to center of bond pad.
 Thickness: 0.110 +/- 0.010 (0.0043 +/- 0.0004), Backside is ground, Bond Pad/Backside Metallization: Gold
 All DC Bond Pads are 0.100 x 0.100 (0.004 x 0.004). All RF Bond Pads are 0.100 x 0.200 (0.004 x 0.008)
 Bond pad centers are approximately 0.109 (0.004) from the edge of the chip.
 Dicing tolerance: +/- 0.005 (+/- 0.0002). Approximate weight: 1.572 mg.

Bond Pad #1 (RF In)
Bond Pad #2 (Vd)

Bond Pad #3 (RF Out)
Bond Pad #4 (Vg)

Bias Arrangement

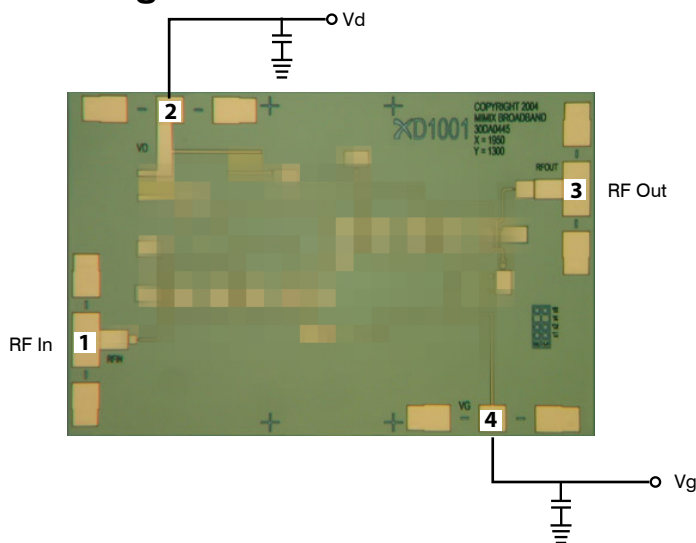

Bypass Capacitors - See App Note [2]

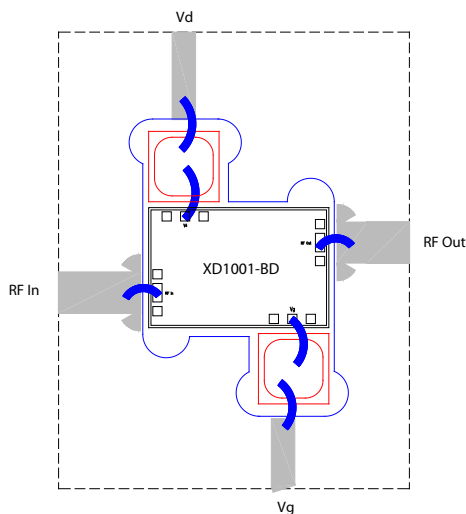

18.0-50.0 GHz GaAs MMIC Distributed Amplifier

January 2010 - Rev 11-Jan-10

App Note [1] Biasing - As shown in the bonding diagram, this device is operated with a single drain and a gain control voltage. Maximum gain bias is nominally $V_d=5.0V$, $V_g=0V$, $I_d=160mA$. Gain can be adjusted by changing V_g . It is recommended to use active biasing to keep the currents constant as the RF power and temperature vary; this gives the most reproducible results. Depending on the supply voltage available and the power dissipation constraints, the bias circuit may be a single transistor or a low power operational amplifier, with a low value resistor in series with the drain supply used to sense the current. The gate of the pHEMT is controlled to maintain correct drain current and thus drain voltage. The typical gate voltage needed to do this is 0.0V. Typically the gate is protected with Silicon diodes to limit the applied voltage. Also, make sure to sequence the applied voltage to ensure negative gate bias is available before applying the positive drain supply.

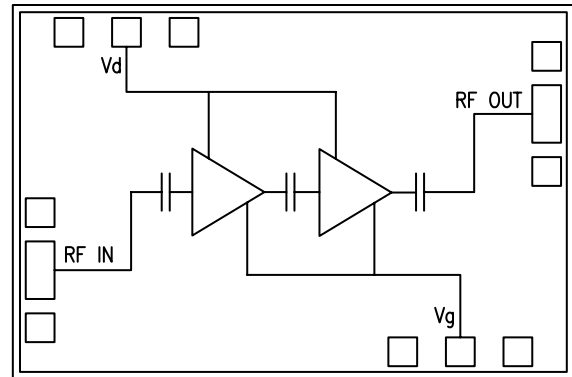

App Note [2] Bias Arrangement - Each DC pad (V_d and V_g) needs to have DC bypass capacitance ($\sim 100-200$ pF) as close to the device as possible. Additional DC bypass capacitance (~ 0.01 uF) is also recommended.

18.0-50.0 GHz GaAs MMIC Distributed Amplifier

January 2010 - Rev 11-Jan-10

MTTF Graphs

These numbers were calculated based upon accelerated life test information received from the fabricating foundry and extensive thermal modeling/finite element analysis done at Mimix Broadband. The values shown here are only to be used as a guideline against the end application requirements and only represent reliability information under one bias condition. Ultimately bias conditions and resulting power dissipation along with the practical aspects, i.e. thermal material stack-up, attach method of device placement are the key parts in determining overall reliability for a specific application, see previous pages. If the data shown below does not meet your reliability requirements or if the bias conditions are not within your operating limits please contact technical sales for additional information.

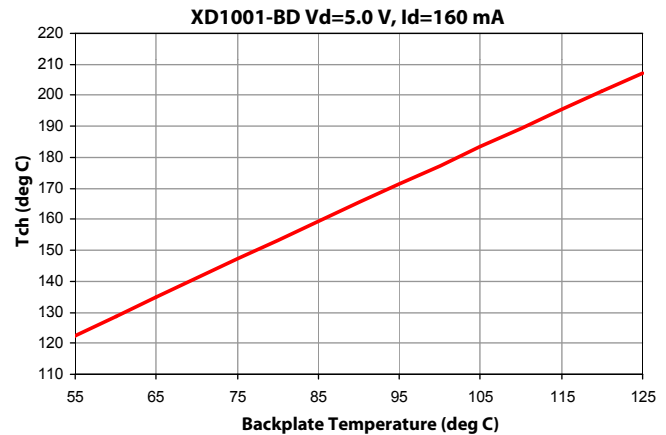
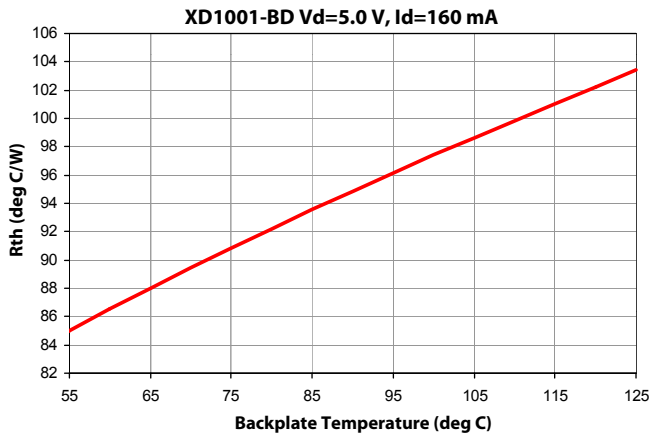
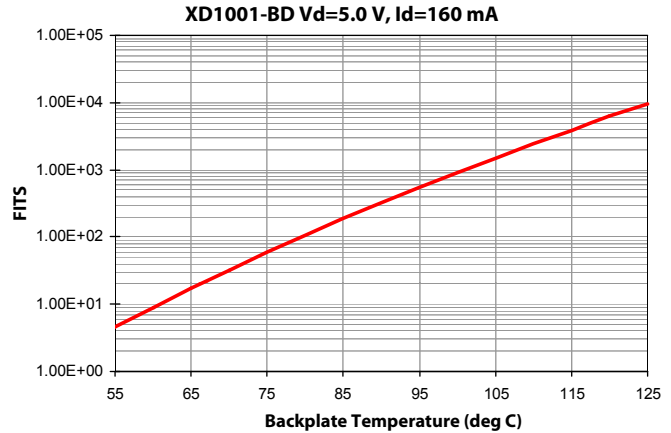
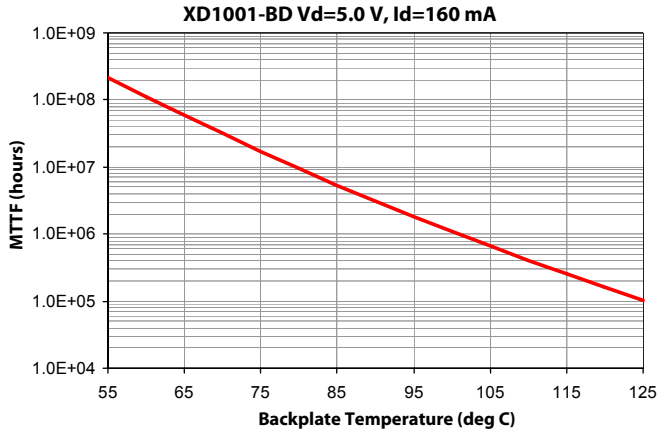

18.0-50.0 GHz GaAs MMIC Distributed Amplifier

January 2010 - Rev 11-Jan-10

Handling and Assembly Information

CAUTION! - Mimix Broadband MMIC Products contain gallium arsenide (GaAs) which can be hazardous to the human body and the environment. For safety, observe the following procedures:

- Do not ingest.
- Do not alter the form of this product into a gas, powder, or liquid through burning, crushing, or chemical processing as these by-products are dangerous to the human body if inhaled, ingested, or swallowed.
- Observe government laws and company regulations when discarding this product. This product must be discarded in accordance with methods specified by applicable hazardous waste procedures.

Life Support Policy - Mimix Broadband's products are not authorized for use as critical components in life support devices or systems without the express written approval of the President and General Counsel of Mimix Broadband. As used herein: (1) Life support devices or systems are devices or systems which, (a) are intended for surgical implant into the body, or (b) support or sustain life, and whose failure to perform when properly used in accordance with instructions for use provided in the labeling, can be reasonably expected to result in a significant injury to the user. (2) A critical component is any component of a life support device or system whose failure to perform can be reasonably expected to cause the failure of the life support device or system, or to affect its safety or effectiveness.

ESD - Gallium Arsenide (GaAs) devices are susceptible to electrostatic and mechanical damage. Die are supplied in antistatic containers, which should be opened in cleanroom conditions at an appropriately grounded antistatic workstation. Devices need careful handling using correctly designed collets, vacuum pickups or, with care, sharp tweezers.

Die Attachment - GaAs Products from Mimix Broadband are 0.100 mm (0.004") thick and have vias through to the backside to enable grounding to the circuit. Microstrip substrates should be brought as close to the die as possible. The mounting surface should be clean and flat. If using conductive epoxy, recommended epoxies are Tanaka TS3332LD, Die Mat DM6030HK or DM6030HK-Pt cured in a nitrogen atmosphere per manufacturer's cure schedule. Apply epoxy sparingly to avoid getting any on to the top surface of the die. An epoxy fillet should be visible around the total die periphery. For additional information please see the Mimix "Epoxy Specifications for Bare Die" application note. If eutectic mounting is preferred, then a fluxless gold-tin (AuSn) preform, approximately 0.001² thick, placed between the die and the attachment surface should be used. A die bonder that utilizes a heated collet and provides scrubbing action to ensure total wetting to prevent void formation in a nitrogen atmosphere is recommended. The gold-tin eutectic (80% Au 20% Sn) has a melting point of approximately 280 °C (Note: Gold Germanium should be avoided). The work station temperature should be 310 °C +/- 10 °C. Exposure to these extreme temperatures should be kept to minimum. The collet should be heated, and the die pre-heated to avoid excessive thermal shock. Avoidance of air bridges and force impact are critical during placement.

Wire Bonding - Windows in the surface passivation above the bond pads are provided to allow wire bonding to the die's gold bond pads. The recommended wire bonding procedure uses 0.076 mm x 0.013 mm (0.003" x 0.0005") 99.99% pure gold ribbon with 0.5-2% elongation to minimize RF port bond inductance. Gold 0.025 mm (0.001") diameter wedge or ball bonds are acceptable for DC Bias connections. Aluminum wire should be avoided. Thermo-compression bonding is recommended though thermosonic bonding may be used providing the ultrasonic content of the bond is minimized. Bond force, time and ultrasonics are all critical parameters. Bonds should be made from the bond pads on the die to the package or substrate. All bonds should be as short as possible.

Part Number for Ordering

XD1001-BD-000V
XD1001-BD-EV1

Description

RoHS compliant die packed in vacuum release gel packs
XD1001-BD evaluation module



Caution: ESD Sensitive
Appropriate precautions in handling, packaging
and testing devices must be observed.

Proper ESD procedures should be followed when handling this device.

Mimix Broadband, Inc., 10795 Rockley Rd., Houston, Texas 77099
Tel: 281.988.4600 Fax: 281.988.4615 mimixbroadband.com

Page 8 of 8